

From Serial Number 18007975

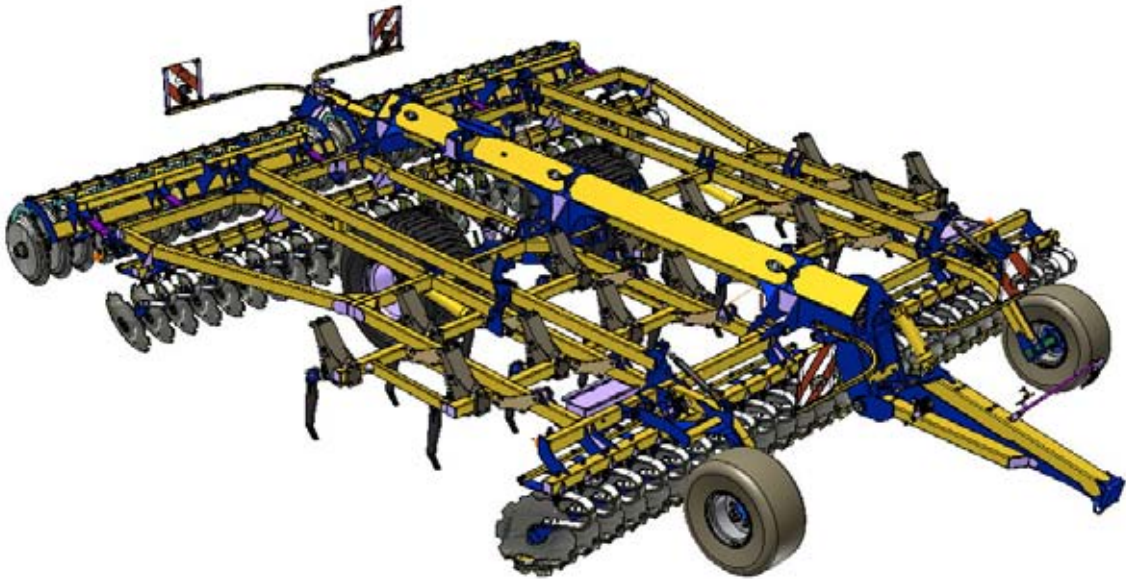

P14888 06/06/08





**DECLARATION OF CONFORMITY**

Simba International Limited hereby declare that the Product described in this Operators Manual, and defined by the Serial Number Plate attached to the Chassis of the Machine (a part copy of which is detailed overleaf and must be completed indicating the relevant machine details), conforms with the following Directives and Regulations, and has been certified accordingly.

**EC Machinery Directive 89/392/EEC, as amended by 91/3688/EEC, 93/44/EEC, and 93/688/EEC.**

In order to fulfill the requirements of health and safety described in the EC Directive, the following standards and technical specifications have been taken into account:

**EN 292 - 1**  
**EN 292 - 2**

**THE MANUFACTURER**

Simba International Limited  
Woodbridge Road  
SLEAFORD  
Lincolnshire  
NG34 7EW  
England.

Telephone 01529 304654.

**CERTIFIED ON BEHALF OF SIMBA INTERNATIONAL LIMITED.**

Rod Daffern  
Chairman  
Simba International Limited



## **WARRANTY** **TERMS AND CONDITIONS**

In this warranty Simba International Ltd., is referred to as “the Company”.

1. Subject to the provisions of this warranty the Company warrants each new machine sold by it to be sold free from any defect in material or workmanship for a period of 12 months from date of installation with the end-user.

Some specific items have additional warranty over and above the standard 12 months. Details of these can be obtained upon request directly from the distributor or Simba International Ltd.

2. If the machine or part thereof supplied by the Company is not in accordance with the warranty given in clause 1 the Company will at its option:

- (a) make good the machine or part thereof at the Company's expense, or
- (b) make an allowance to the purchaser against the purchase price of the machine or part thereof, or
- (c) accept the return of the machine and at the buyers option either:
  - I) repay or allow the buyer the invoice price of the machine or part thereof, or
  - II) replace the machine or part thereof as is reasonably practical.

3. This warranty shall not oblige the Company to make any payment in respect of loss of profit or other consequential loss or contingent liability of the Purchaser alleged to arise from any defect in the machine or impose any liability on the Company other than that contained in clause 2.

4. Any claim under this warranty must be notified to the Company in writing specifying the matters complained of within 14 days from the date of repair.

5. Any claim under this warranty must be made by the original purchaser of the machine and is not assignable to any third party.

6. If the purchaser hires out the machine to any third party the warranty shall apply only to matters notified to the Company in writing within 90 days of the date of delivery and clause 1 shall be read as if the period of 90 days were substituted for the period of 12 months.

7. The warranty will cease to apply if:

- (a) any parts not made, supplied or approved in writing by the Company are fitted to the machine or
- (b) any repair is carried out to the machine other than by or with the express written approval of the Company or
- (c) any alterations not expressly authorized by the Company in writing are made to the machine or
- (d) the machine is damaged by accident or
- (e) the machine is abused or overloaded or used for a purpose or load beyond its design capabilities, or used in conjunction with a tractor whose power output capability exceeds the stated implement power requirement by more than 40%. For the purpose of these terms and conditions, “stated implement power requirement” refers to wheeled tractors unless specifically stated. These power requirements should be reduced by 20% when used in conjunction with tracked tractors.
- (f) the machine is operated as part of a ‘cultivation train’ where more than one implement is being towed, without the express written approval of Simba International Ltd.
- (g) any maintenance is not carried out in accordance with the service schedules in the operator's manual.
- (h) the Installation and Warranty Registration Certificate is not received by Simba International Ltd., Service Dept., Woodbridge Road, Sleaford, Lincolnshire, England, NG34 7EW, within 7 days of installing a new machine.

## Machine Identification

Enter the relevant data in the following list upon acceptance of the machine:

Serial Number	
Type of Machine	
Machine Width	
Year of Construction	
Delivery Date	
First Operation	
Accessories	

Operating Instructions/Spare Parts List: June 2008

Dealer Address:      Name: .....  
                         Street: .....  
                         Place: .....  
                         Tel.: .....

Dealer's Customer No.: .....

SIMBA Address:      SIMBA  
                         Woodbridge Road Ind. Est.  
                         Sleaford  
                         Lincolnshire  
                         NG34 7EW

Tel.:            01529 304654  
Fax:            01529 413468  
E-Mail:        simba.international@simba.co.uk

SIMBA Customer No.: .....

# Contents

Machine Identification .....	5
<b>Introduction .....</b>	<b>8</b>
Forward .....	5
Warranty Guidelines .....	8
<b>1. Safety Data .....</b>	<b>9</b>
1.1 Safety Symbols .....	9
1.2 Use for the Intended Purpose .....	11
1.3 Operational Safety .....	11
1.3.1 No Liability for Consequential Damage .....	11
1.4 Road Traffic Safety .....	12
1.5 Accident Prevention .....	12
1.5.1 Hitching-up the machine .....	12
1.5.2 On the Hydraulic System .....	12
1.5.3 Changing Equipment .....	13
1.5.4 During Operation .....	13
1.6 Servicing & Maintenance .....	13
1.7 Operating Areas .....	14
1.8 Authorised Operators .....	14
1.9 Protective Equipment .....	14
<b>2. Transportation and Installation .....</b>	<b>15</b>
2.1 Delivery .....	15
2.2 Transportation .....	15
2.3 Installation .....	15
2.4 Hitching Up .....	16
2.4.1 Hitching up a Tractor to the SL700 / Preparing for Transport .....	16
2.5 Folding and Unfolding .....	17
2.5.1 Unfolding into the Work Position .....	17
2.5.2 Folding into the Transport Position .....	17
2.6 Trailing Implements .....	18
2.6.1 Hitching a Press Roll to the SL700 .....	18
2.7 When driving on the road .....	18
2.8 Parking the machine .....	18
<b>3. Technical Data SL700 .....</b>	<b>19</b>

<b>4.</b>	<b>Adjustment/Operation .....</b>	<b>20</b>
4.1	Description .....	20
4.2	Depth Wheels .....	21
4.3	Disc Units .....	22
4.4	Terra-Grip Tines .....	22
4.5	Double Disc Roller .....	23
4.6	Work Settings .....	24
4.7	Starting Settings .....	24
4.8	Depth Control .....	26
4.9	Work Instructions .....	27
4.10	Parking the machine .....	27
4.11	Checks .....	27
<b>5.</b>	<b>Servicing and Maintenance .....</b>	<b>28</b>
5.1	Servicing .....	28
5.2	Cleaning .....	28
5.3	Disc Hub Maintenance .....	28
5.3.1	Tightening Disc Hubs .....	28
5.3.2	Bearing Seals .....	29
5.4	Terra-Grip Tine Points .....	29
5.5	Double Disc Axles .....	29
5.6	Wing Pitch .....	29
5.7	Brakes and Wheel Hubs .....	29
5.8	Hydraulics .....	30
5.9	Preparation for Storage .....	30
5.10	Operator Support .....	30
5.11	Maintenance Intervals .....	30
5.12	Maintenance Overview .....	31
5.13	Overview of Lubricating Points .....	32
5.14	Lubricating the Machine .....	34
5.15	Handling of Lubricants .....	34
5.16	Lubricants & Hydraulic Oil .....	35
<b>6.</b>	<b>Faults and Remedies .....</b>	<b>36</b>
<b>7.</b>	<b>Parts and Assembly .....</b>	<b>37</b>

## Introduction

### Foreword

Make sure you have read and follow the Operating Instructions carefully before using the machine. By doing so, you will avoid accidents, reduce repair costs and downtime and increase the reliability and service life of your machine. Pay attention to the safety instructions!

SIMBA will not accept any responsibility for any damage or malfunctions resulting from failure to comply with the Operating Instructions.

These Operating Instructions will assist you in getting to know your machine and in using it correctly for its intended purposes. First, you are given general instructions in handling the machine. This is followed by sections on servicing, maintenance and the action to be taken should a malfunction occur.

These operating instructions are to be read and followed by all persons working on or with the machine, e.g.:

- Operation (including preparation, remedying of faults in the operating sequence and servicing).
- Maintenance (maintenance and inspection)
- Transportation.

Together with the Operating Instructions, you receive a Spare Parts List and a Machine Registration form. Field service technicians will instruct you in the operation and servicing of your machine. Following this, the Machine Registration form is to be returned to SIMBA. This confirms your formal acceptance of the machine. The warranty period begins on the date of delivery.



We reserve the right to alter illustrations as well as technical data and weights contained in these Operating Instructions for the purpose of improving the SL700.

### Warranty Guidelines

1. The period of liability for material defects (warranty) relating to our products is 12 months. In the case of written deviations from the statutory provisions, these agreements shall apply.

They shall become effective upon installation of the machine with the end customer. All wear parts are excluded from the warranty.

2. Warranty claims must be submitted to the SIMBA Customer Service Department in Sleaford via your dealer. It is only possible to process claims which have been correctly completed and submitted no later than 14 days after the date of repair.

3. In the case of deliveries made under the warranty which are subject to the return of the old parts, the old parts must be returned to SIMBA within 28 days after the damage occurred.

4. In the case of deliveries made under the warranty which are not subject to the return of the old parts, these parts must be kept for the purpose of further decisions for a period of 3 months after receipt of the warranty claim.

5. Warranty repairs to be carried out by outside companies, or repairs which are expected to take more than 10 working hours, must be agreed upon in advance with the Customer Service Department.

# 1. Safety Data

The following warnings and safety instructions apply to all sections of these Operating Instructions.

## 1.1 Safety Symbols

### On the machine



Parts may fly off during operation. Keep a safe distance away from the machine!

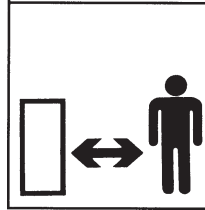

Read and observe the Operating Instructions before starting up the machine!

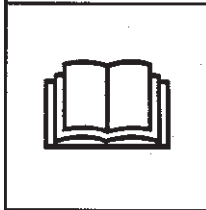

Keep clear of the working range of foldable machine components!

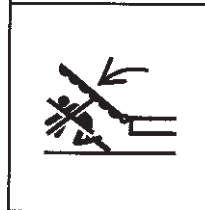

Watch out for escaping pressurised fluids! Follow the instructions in the Operating Instructions!

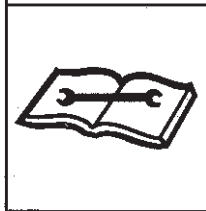

No passengers are allowed on the machine!



Never reach into areas where there is a danger of being crushed by moving parts!

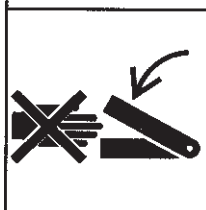

Never reach into any revolving parts!

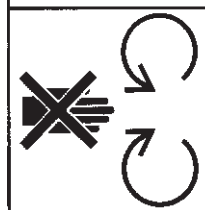



Refer to Operating Instructions before attempting maintenance.

### Operating Instructions:

The Operating Instructions distinguish between three different types of warning and safety instructions. The following graphic symbols are used:



Important!



Risk of injury!



Risk of fatal and serious injuries!

It is important that all the safety instructions contained in these Operating Instructions and all the warning signs on the machine are read carefully.

Ensure that the warning signs are legible. Replace any signs that are missing or damaged.

These instructions must be followed in order to prevent accidents. Inform other users of the warnings and safety instructions.

Do not carry out any operations which may affect safe use of the machine.

## 1.2 Use for the Intended Purpose

The SIMBA SL700 is built using the latest technology and in accordance with the relevant recognised safety regulations. However, risks of injury for the operator or third parties and impairment of the machine or other tangible assets can arise during use.

The machine is only to be operated when in a technically perfect condition and for the intended purpose, taking into consideration safety and risks and following the Operating Instructions. In particular, faults that can impair safety are to be remedied immediately.

Original parts and accessories from SIMBA have been specially designed for this machine. Spare parts and accessories not supplied by us have not been tested or authorised. Installation or use of non-original SIMBA products may have a detrimental effect on specific design features of the machine and affect the safety of machine operators and the machine itself. SIMBA will accept no liability for damage resulting from the use of non-original parts or accessories.

The SIMBA SL700 is designed solely as a cultivation implement. Use for any other purpose, e.g., as a means of transport, will be deemed to be improper use. SIMBA will accept no liability for damage resulting from improper use. The risk will be borne solely by the operator.

## 1.3 Operational Safety

The machine is to be put in operation only after instruction has been provided by an employee of the authorised dealer or an employee of SIMBA. The "Machine Registration" form is to be completed and returned to SIMBA.

All protective and safety equipment, such as removable protective equipment, must be in place and functioning reliably before the machine is put in use.



Check screws and bolts regularly for tightness and retighten if necessary.



In the event of malfunctions, stop and secure the machine immediately.



Ensure that any faults are remedied immediately.

### 1.3.1 No Liability for Consequential Damage

The SL700 has been manufactured by SIMBA with great care. However, problems may still occur when it is used for the intended purpose. These may include:

- Worn wearing parts.
- Damage caused by external factors.
- Incorrect driving speeds.
- Incorrect setting of the unit (incorrect attachment, non-adherence to the Setting instructions).



Therefore, it is crucial to always check your machine before and during operation for correct operation and adequate application accuracy.

Compensation claims for damage which has not occurred to the machine is excluded. This includes any consequential damage resulting from incorrect operation.

## 1.4 Road Traffic Safety

When driving on public roads, tracks and areas, it is important to observe the relevant road traffic laws as well as the specific regulations relating to this machine.



Pay attention to the permitted axle loads, tyre carrying capacity, and total weight in order to maintain adequate braking and steerability.



Passengers on the machine are strictly forbidden!



Max. road transport speed 16mph (25km/h).

## 1.5 Accident Prevention

In addition to the Operating Instructions, it is important to observe the accident prevention regulations specified by agricultural trade associations.

### 1.5.1 Hitching-up the machine

There is a risk of injury when hitching/unhitching the machine. Observe the following:

- Secure the machine against rolling.
- Take special care when reversing the tractor!
- There is a risk of being crushed between the machine and the tractor!
- Park the machine on firm, level ground.

### 1.5.2 On the Hydraulic System

Do not connect the hydraulic lines to the tractor until both hydraulic systems (machine and tractor) are depressurised.



Any hydraulic system containing an accumulator can remain under pressure permanently (even after following manual depressurisation procedures with a tractor / implement combination). It is therefore important to check all lines, pipes, and screw connections regularly for leaks and any recognisable external damage.

Only use appropriate aids when checking for leaks. Repair any damage immediately. Spurting oil can cause injuries and fires!

In case of injury, contact a doctor immediately.

The socket and plugs for the hydraulic connections between the tractor and the machine should be colour-coded in order to avoid incorrect use.

### 1.5.3 Changing Equipment

- Secure the machine to prevent it from accidentally rolling away!
- If attached to a tractor ensure that the tractor handbrake is on.
- Use suitable supports to secure any raised frame sections suspended above you! Ensure all hydraulic taps are closed if working under the machine.
- Caution! Risk of injury due to projecting parts!



Never climb on to rotating parts such as the roll unit. These parts may rotate causing you to slip and suffer serious injury!

### 1.5.4 During Operation

Ensure that the working range and the area around the machine are clear (children!) before operating the machine.

Always ensure adequate visibility!

Do not stand on the machine while it is in operation!

Operators must have a valid driving licence in order to drive on public roads. In the operating area, the operator is responsible for third parties.

The person in charge must:

- provide the operator with a copy of the Operating Instructions, and
- ensure that the operator has read and understood the instructions.
- make sure that the operator is aware of the specific regulations relating to the machine when driving on public roads.

## 1.6 Servicing & Maintenance

Ensure that regular checks and inspections are always carried out within the periods required by law or specified in these Operating Instructions.

When carrying out service and maintenance work always:

- switch off the tractor engine and remove the ignition key.
- wait until all the machine parts have stopped moving.
- depressurize the hydraulic system.

Prior to performing maintenance and servicing work, ensure that the machine is positioned on solid, level ground and is secured to prevent it rolling away. Do not use any parts to climb on to the machine unless they are specifically designed for this purpose.

Before cleaning the machine with water, steam jets (high-pressure cleaning apparatus) or other cleaning agents, cover all openings into which, for reasons of safety or operation, no water, steam or cleaning agents are to penetrate (bearings, for instance).

Next, check all hydraulic lines for leaks, loose connections, chafe marks and damage. Remedy any deficiencies immediately!

Lubricate all the lubricating points to force out any trapped water.

When carrying out servicing and maintenance work, retighten any loose screw connections.

## **1.7 Operating Areas**

The operating areas include the drawbar, hydraulic connections and depth adjustment equipment as well as all operating points requiring maintenance.

All operating areas will be specified and described in detail in the following chapters on servicing and maintenance.

Observe all safety regulations included in the Section dealing with Safety, and in the subsequent sections.

## **1.8 Authorised Operators**

Only those persons who have been authorised and instructed by the operator may operate the machine. The operator must be at least 16 years of age.

## **1.9 Protective Equipment**

For operation and maintenance, you require:

- Tight fitting clothing.
- Strong protective gloves (to provide protection against sharp-edged machine components).
- Protective goggles (to stop dirt getting into your eyes).

## 2. Transportation and Installation

Transportation and initial installation of the machine are described in this chapter.

### 2.1 Delivery

The machine is normally delivered fully assembled.

- The machine should be hitched to a tractor and driven off a low-loader.

### 2.2 Transportation

The SL700 can be transported on public roads by hitching it up to a tractor or on a low-loader.

- It is important to observe the permitted dimensions and weights when transporting the machine.
- If the machine is transported on a trailer or a low-loader, it must be secured using straps or other devices.
- Before transporting the machine on public roads, it must be adjusted to its transportation position and the stipulations relating to road transportation fulfilled.
- The maximum permissible speed is 25 km /h.

### 2.3 Installation

When carrying out installation and maintenance work there is a higher risk of injury. It is important that you familiarise yourself with the machine and read the Operating Instructions beforehand.

Operator instruction and initial installation of the machine are carried out by our service technicians or authorised distributors.

The machine must not be used in any way beforehand! The machine can only be released for operation after instructions have been provided by our service technicians or authorised distributors.

- If any modules or parts have been removed for transportation, these shall be mounted by our service technicians/authorised dealers before the instruction takes place.
- Check all important screw connections!
- Lubricate all nipples and joints!
- Check all hydraulic connections and lines for damage.

## 2.4 Hitching Up

### 2.4.1 Hitching up a Tractor to the SL700 / Preparing for Transport



When hitching-up the machine, ensure that no-one is between the tractor and the machine.



When the SL700 is parked for extended periods of time it should ideally be left in the unfolded, i.e. work position for stability, safety and ease of access for maintenance. However, parking the SL700 in the folded position (ensuring the transport lock is engaged) is acceptable in the normal course of operation.



#### **Tractor Oil Flow Adjustment:**

As a general rule the tractor oil flow rate should be set in the lowest setting before starting. This can then be increased to allow the desired rate of operation as applicable. This will minimise excessive oil flow and consequent power usage and heat generation.

1. Ensure the tractor hydraulics are depressurised and in the locked or closed (not float) setting.
2. Couple the hydraulic hoses to the tractor ensuring that the two wing hoses (yellow) are together, the two drawbar cylinder hoses (red) are together, the tine frame hoses (green) and the rear roll hoses (blue) are together.
3. Connect the tractor to the drawbar using the hydraulics to raise or lower the height of the shackle.

4. Carefully operate the hydraulics to lower the drawbar and tilt the SL700 onto the road transport wheels. Extend the drawbar cylinder and lift axle cylinder enough to add in the requisite amount of shims for road transport. Ordinarily a 51mm silver shim in each lift cylinder should be used to give a transport height of 3930mm, however the machine can be transported without shims in the lift cylinders provided that road conditions are suitable (this gives a transport height of 3850mm).
5. Ensure that the wing lock is engaged correctly before transporting the machine.
6. If the machine is already folded it is now ready for transport. If the machine is unfolded please refer to 2.5.2.



Fig. 2.01: Transport Lock

## 2.5 Folding and Unfolding

### 2.5.1 Unfolding into the Work Position

- 1 Raise the machine until the pointer is aligned with the mark on the lift cylinder.
- 2 Fully extend the tine beam to release the transport lock.
- 3 Unfold the machine until the pointer reaches the red line on the wing cylinder and stop. (Using the pointers / markers ensures that the machine is folding under 4m).

 Ensure the wings unfold together (ie. symmetrically). If they don't, fold them and start again.

- 4 Fully retract the tine beam.
- 5 Raise the machine enough for the wings to clear the ground when unfolding.
- 6 Resume unfolding the wings until fully unfolded.



Fig. 2.02: Lift Cylinder Pointer and Marker



Fig. 2.03: Wing Cylinder Pointer and Marker

### 2.5.2 Folding into the Transport Position

- 1 Draw up the rear roll and isolate the circuit using the taps.
- 2 Retract the tine beam.
- 3 Raise the machine enough for the wings to clear the ground when folding.
- 4 Fold the machine until the marker on the wing cylinder reaches the red line.

 Ensure the wings fold together (ie. symmetrically). If they don't, unfold them and start again.

- 5 Lower the machine until the marker on the lift cylinder reaches the red line.
- 6 Finish folding the machine until the wing lock engages.
- 7 Lower the machine the remainder of the way onto the transport shims.
- 8 The machine is now ready for road transport.

 Road transport speed should not exceed 16mph (25kmh).



Fig. 2.04: Folding the SL700

## 2.6 Trailing Implements

### 2.6.1 Hitching a Press Roll to the SL700

 Maximum rear drawbar vertical loading - 650kg

1. Raise Machine to remove shims from the lift axle to allow rear drawbar to be raised/lowered.
2. Reverse the SL700 up to the press roll, ensuring that the drawbars are correctly aligned allowing a slight clearance to enable the machines to be coupled together.
3. Lower the SL700 to the ground.
4. Attach the hydraulic hoses between the SL700 and the press roll.
5. Open the taps on the press roll drawbar.
6. Raise the press roll drawbar to approximately 300mm above the SL700 drawbar clevis.
7. Close the press roll drawbar taps.
8. Raise/lower the SL700 to the same height as the press roll drawbar, then reverse the SL700 to couple the two machines together.
9. Open the taps on the press roll drawbar.
10. Fully raise both machines into the road transport position.
11. Close the taps on the press roll drawbar.



Ensure that no fouling occurs between the SL and the towed machine.



Any tines on the towed machine should be adjusted so that they do not engage the soil (or should be removed altogether). In instances where a Simba UniPress is towed behind the SL the UniPress tine frame should be removed completely.

### 2.7 When driving on the road

When driving on the road the machine must be converted to the transportation position.



When driving on the road, ensure adequate clearance to prevent the working elements dragging on the ground.

### 2.8 Parking the machine

In order to avoid damage as a result of moisture, the machine should be parked, if possible, indoors or under cover.



When manoeuvring the machine, pay attention to your surroundings. Ensure that nobody is in the manoeuvring area (watch for children!).

- Park the machine on level and solid ground.
- Raise the machine and remove shims from the lift axle and drawbar cylinders.
- Lower the machine to the ground, ensuring that it is stable.



When parking with the machine unfolded, ensure that no load is carried by the Terra-Grip tines. This can lead to breakage of the points.

- Remove the drawbar pin and drive forward slowly until hitch is clear of tractor drawbar.
- Lower the drawbar to the ground.
- Switch off the tractor.
- Disconnect hydraulic lines from the tractor.

### 3. Technical Data SL700

	<b>SL700</b>
<b>Working Width</b>	6700mm
<b>Transport Width</b>	2950mm
<b>Transport Height</b>	3930mm
<b>Length</b>	10100mm
<b>Weight</b>	11500kg
<b>Tractor Power Required (H.P.)*</b>	350+

\* It is important to correctly match your implement to your tractor for optimum performance.

<b>Total weight:</b>		11500kg
<b>Drawbar load Vmax</b>	<b>(1)</b>	1180kg
<b>Axle load</b>	<b>(2)</b>	10320kg
<b>Drawbar Hitch:</b>		Simba P09067
<b>Standard:</b>		PPI-421 V3
<b>Data:</b>	<b>D</b>	467kN
	<b>V</b>	3665kg
<b>Axle:</b>		AAOUI 10T G
<b>Max load permissible:</b>		15000kg @ 25km/h
<b>TUV :</b>	<b>G</b>	14000kg
<b>Tractor: Minimum Weight:</b>		10000kg
<b>Maximum Power:</b>		350kW

## 4. Adjustment/Operation

### 4.1 Description

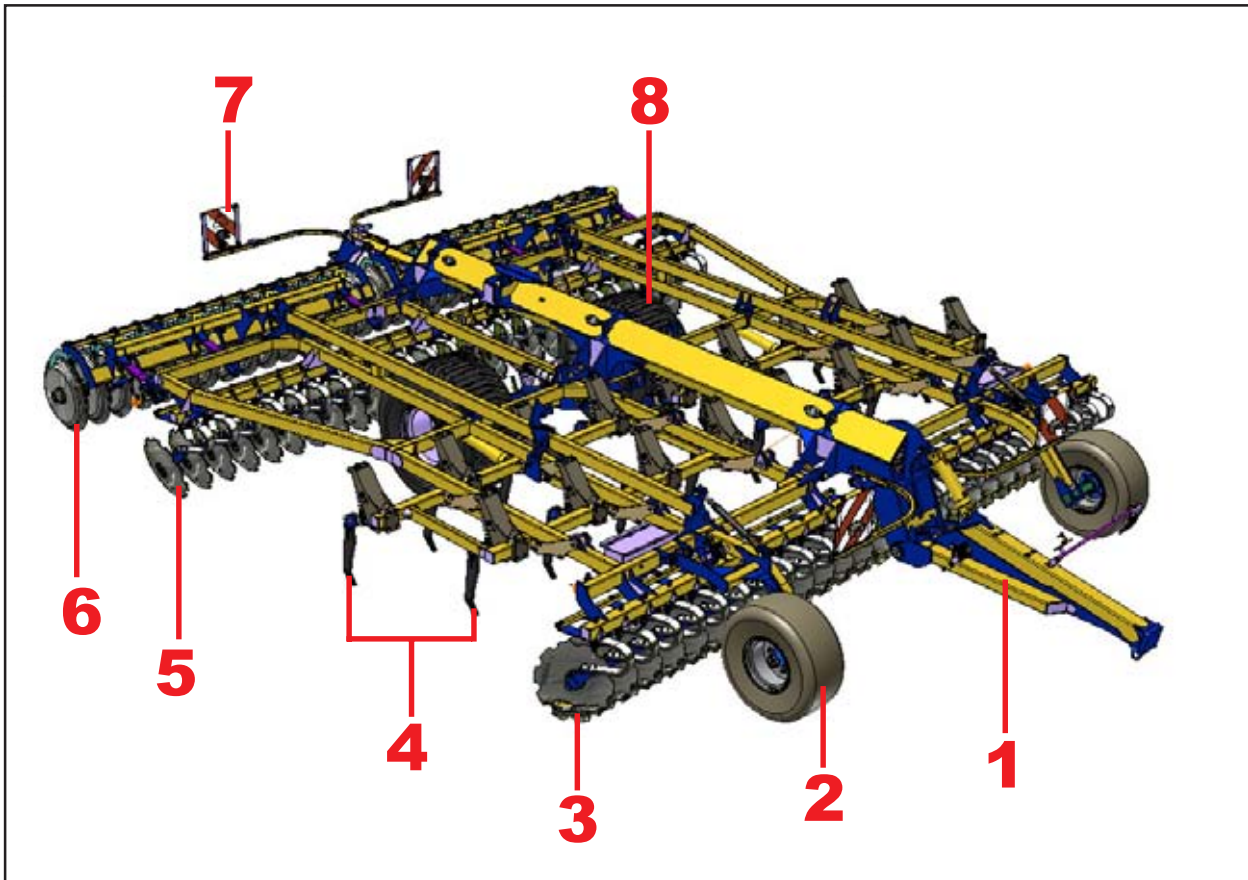

Fig. 4.01: Simba SL700

1. Drawbar
2. Front Depth Wheels
3. Front Discs
4. Terra-Grip Tines
5. Rear Discs
6. DD700 Roll
7. Lights
8. Transport Wheels

The **SIMBA SL700** is an amalgamation of time proven, successful Simba design components brought together to form this important development. The SL700 has been designed and produced in conjunction with the Simba **ECOtillage™** system to provide a one pass mix with a fissured layer at disc depth for through drainage and root access to lower horizons. This enables rapid drainage and access after rain, creating a greater effective capacity for moisture compared to ploughing for the same effective total depth of cultivation.

In principle, the machine is an offset disc with Terra-Grip tines, designed for low draft, high speed operations. The addition of a levelling board and rear mounted roll enables more effective cultivation in one pass. The leading set of disc blades cultivate the top horizon, minimising clod formation and reducing tine loadings and blockage. This starts the 'top down' cultivation process, retaining weathered tilth in the surface level for stale seedbed purposes. The tines follow the disc blades to shatter at depth retaining the surface intact to work as an **ECOtillage™** stale seedbed. This eliminates the problem of 'wet years' in non-plough based terms. The key to the SL700's success is the lower draft tine point and wing which maintain shatter across the full width of cultivation. The rear roll then consolidates the surface, cracks any clods and firms the soil profile after the rear gang completes mixing to depth. The corrugated top and shattered lower horizons are left fully weatherproof to any conditions between cultivation and drilling whilst retaining moisture below the surface for rapid straw breakdown and optimum establishment of the next crop.

## 4.2 Depth Wheels

The depth wheel units support the front of the machine helping to reduce the load on the drawbar / rear of tractor in work and ensuring a level soil finish.

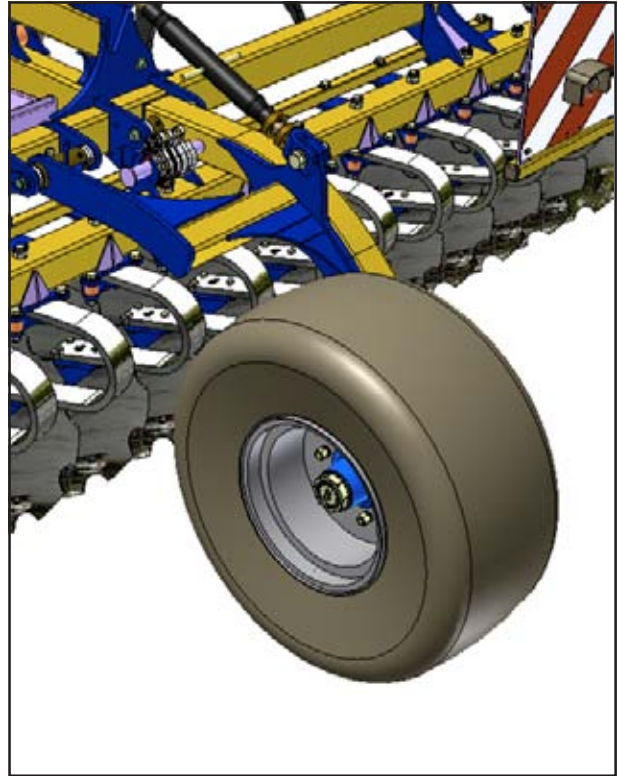

Fig. 4.02: Depth Wheels

### 4.3 Disc Units

The SL700 features two rows of discs which chop and mix the crop residue. A disc spacing of 250mm ensures a fine tilth.

The discs fitted to the SL700 are 610mm in diameter (24") and 6mm thick. They are manufactured from heat treated chrome boron steel which ensures excellent wear resistance and enhanced working life.

Each disc is mounted on a Pro-Flex sprung leaf linked to a track rod system. Gang angles can be varied with ease and accuracy using a graduated adjuster.

Adjustable angling of the discs (between 10°-25°) ensures penetration and stubble mixing are achieved in one pass. All this is achieved without compromise to consolidation.

A level, evenly cultivated finish is maintained by adjusting the balance of soil throw between the front and rear disc.

Sprung Pro-Flex leaves offer protection against damage as well as offering a degree of contour following as they flex up and down in work.

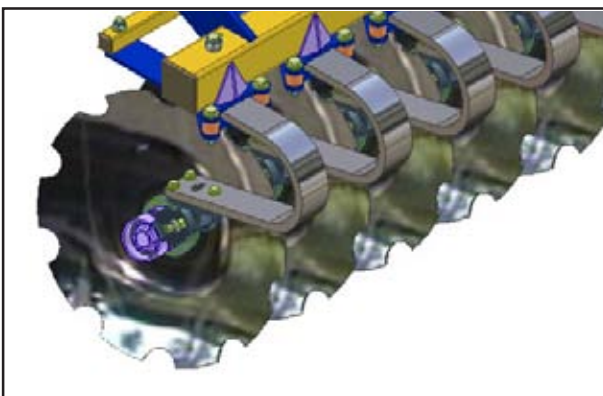

Fig. 4.03: Front Disc Gang

### 4.4 Terra-Grip Tines

Terra-Grip tines have a robust, basic construction and are suitable for all soil types.

The spring-loaded auto-reset system with a 500kg trip force on each tine prevents damage to the tines and tine brackets.

When the auto reset system is activated an initial progressive phase holds the tine in the ground in a steady position until the trip point is reached. In the subsequent spring compression phase the tine is raised gently and rapidly to a maximum height of 230mm.

The tines can be fitted with a selection of points depending on application and have 6 depth settings in 25mm increments.

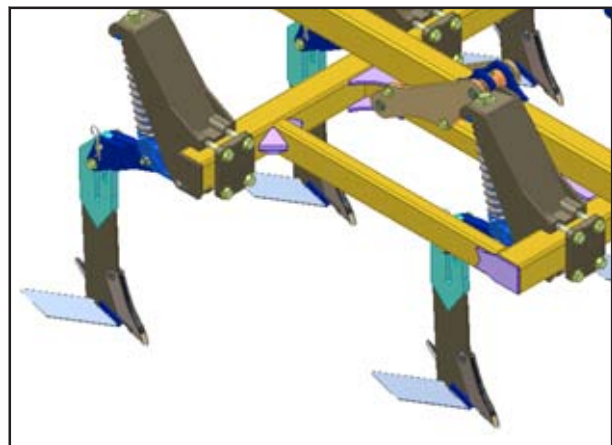

Fig. 4.04: Terra-Grip Tines (Low Disturbance tines shown)

## 4.5 Double Disc Roller

The standard DD700 roller is made up of individual Double Disc (patented) Ring segments.

The DD rings are designed to consolidate the soil whilst cutting and crushing any clods.

Even in heavy, wet soils it can easily be operated with minimal blockages occurring.

The rear DD roller carries a proportion of the machine's weight to ensure consolidation. It also regulates the depth of the machine. The corrugated surface left by the roller is weatherproof both for wet or dry situations.

After hydraulically setting the rear roll depth the circuit should be isolated using the tap.

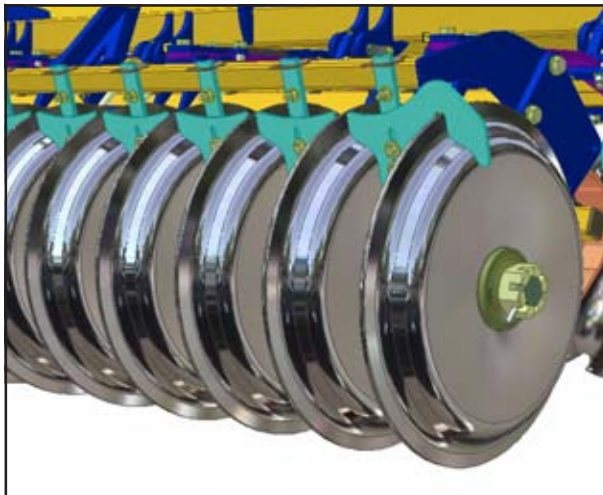

Fig. 4.05: DD700 Roll

## 4.6 Work Settings

In work the wing cylinders should be fully extended. A simple pressurised hydraulic circuit automatically sets itself as the wings are unfolded.

Optimum performance has been found to be achieved when the press roll rings have worn away the painted finish leaving a smooth shiny surface. When the press roll rings are new or rusty, soil may tend to pick up on the surface and blockage may occur, this will reduce when the rings are shiny again.

The SL700 should be run with the chassis level by extending the drawbar cylinder to the necessary position and adding shims as appropriate. In practice it is possible to use the SL700 on ground conditions that are unsuitable to achieve the desired effect, and it is usually possible to operate without regular blockage under such unsuitable conditions, assuming that the axles are tight and rings smooth. As such, especially under wet conditions, it is advisable to check on the cultivation effect of the SL700.

Generally a forward speed of 5-7 mph (8-11 kph) will achieve optimum results, maximising inversion and burial. Speeds in excess of those stated above will tend to give a deterioration in the quality of the work. This may be seen as a ridge and trough effect across the work surface due to soil being thrown too far by the leading discs, the rear discs then are unable to turn enough soil back.

In normal operation the machine should be carried between the rear roll and front depth wheels with the lift circuit in float.

If using the machine without the front depth wheels it should be hydraulically drawn onto the drawbar shims. It is permissible to operate the lift circuit in float in order to allow the implement to follow contours as the tractor drawbar drops (eg. over the brow of a hill).

## 4.7 Starting Settings

This section details the recommended starting settings for the SL700. These settings can then be used as a base for further adjustment in order to get the optimum performance from your machine.

Ensure all settings from the left and right hand sides of the machine match each other.

### Drawbar Cylinder



The drawbar cylinder shim settings are subject to the tractor drawbar height. As such, the shim settings shown above are intended as a suggestion only. The machine should be set to run with the chassis level.

## Disc Angles

### Front Gangs

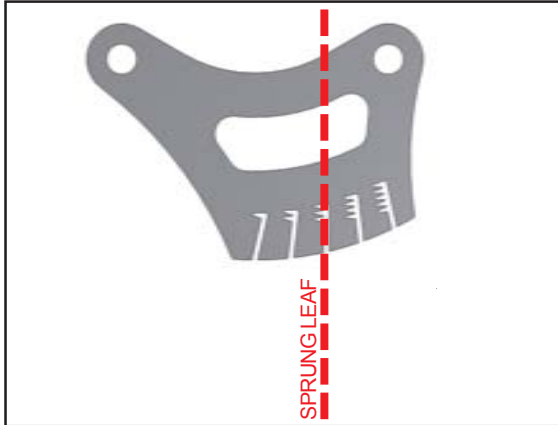

### Rear Gangs

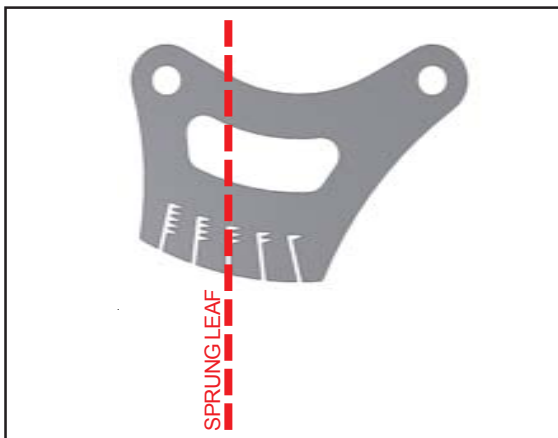

## Transport Cylinders (in road transport)

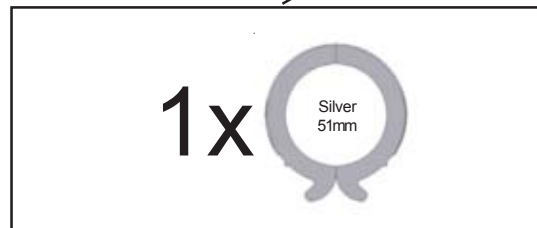

In normal operation a 51mm shim should be left in place at all times except in situations where an extremely low transport height is required (ie when transporting on a lorry).

## Depth Wheels

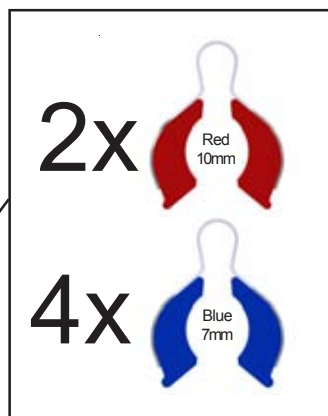

### Roll Depth

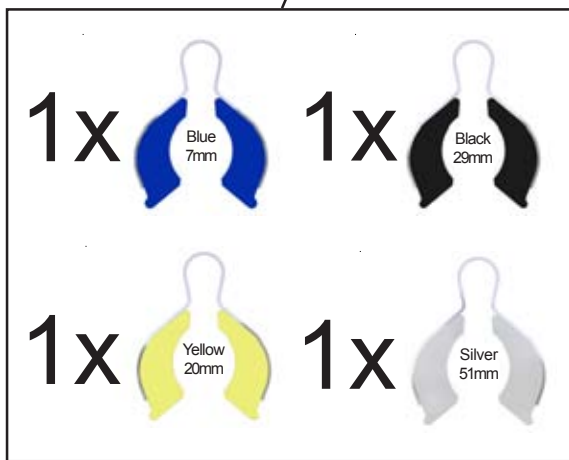

### 4.8 Depth Control

Working depth can be set by rear roll and front depth wheels. Under normal conditions the weight of the machine will be carried on the roll and the front depth wheels, with the main lift wheels either fully up or floating. If the wheels are powered up, then placed in float the axle will hold up until powered down. Depth is set using the depth control cylinders situated on the roll unit with shims added and removed as appropriate, and with the adjusters on the front wheels. The front to rear pitch of the machine should be adjusted as appropriate to compensate for changes in working depth by adjusting the height of the depth wheels.

#### Using the Rear Roll

Use roll depth adjuster/hydraulic cylinder to set machine working depth. The front depth wheels should be adjusted to suit the depth of the rear roll ensuring that the chassis runs level front to rear.

### Tines

As a starting setting, the tine frame should be powered down completely in work.

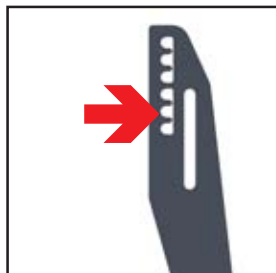

## 4.9 Work Instructions

### Driving speed

The SL700 can be driven at speeds of up to 12 km/h.

This depends on the field conditions (type of soil, surface trash, etc.).

Drive more slowly if the conditions are difficult or a firmer finish is required.

Turning:



Before turning, the machine should be eased out of work while driving. Likewise, it should be eased back into work once the turn has been completed.

It is recommended that the machine should be turned to the left at headlands to reduce the risk of any damage caused by turning with the working elements still engaged.

### 4.10 Parking the machine

In order to avoid damage as a result of moisture, the machine should be parked, if possible, indoors or under cover.



When manoeuvring the machine, pay attention to your surroundings. Ensure that nobody is in the manoeuvring area (watch for children!).

- Park the machine on level and solid ground.
- Raise the machine and remove shims from the lift axle and drawbar cylinders.
- Lower the machine to the ground, ensuring that it is stable.



When parking, ensure that no load is carried by the Terra-Grip tines (if fitted). This can lead to breakage of the points.

- Remove the drawbar pin and drive forward slowly until hitch is clear of tractor drawbar.
- Lower the drawbar to the ground.
- Switch off the tractor.
- Disconnect hydraulic lines from the tractor.

### 4.11 Checks

The working quality depends on the adjustments and checks made prior to and during work, as well as on regular servicing and maintenance of the machine.

Before beginning work it is therefore important to carry out any necessary servicing and to lubricate the machine as required.

#### Checks prior to, and during work:

- Is the machine correctly hitched up and the coupling device locked?
- Have the hydraulic lines been connected according to the colour coding?
- Is the machine in a level operating position and the working depth set correctly?

#### Working Elements

- Are the discs and other cultivation tools in a serviceable condition?
- Are the scrapers still operable, so that the rolls do not jam?

## 5. Servicing and Maintenance



Follow the safety instructions for servicing and maintenance.

### 5.1 Servicing

Your machine has been designed and constructed for maximum performance, operational efficiency and operator friendliness under a wide variety of operating conditions.

Prior to delivery, your machine has been checked at the factory and by your authorised dealer to ensure that you receive a machine in optimum condition.



To ensure trouble-free operation, it is important that servicing and maintenance work is performed at the recommended intervals.

### 5.2 Cleaning

In order to ensure that the machine is always in operating condition and to achieve optimum performance, perform the cleaning and servicing work at regular intervals.

Avoid cleaning the roll / disc bearings with a high- pressure hose or a direct water jet. The housing, screwed connections and ball bearings are not watertight.

### 5.3 Disc Hub Maintenance



Grease every disc hub until grease shows from the seals according to the lubricating intervals outlined on page 32.



Check disc hubs regularly for tightness.



Regularly examine hub caps, seals, shear and pivot bolts and all tracking bolts for tightness and effectiveness twice weekly or every 50 working hours (whichever is more frequent).

#### 5.3.1 Tightening Disc Hubs

- 1 Ensure that the bearing seal is in the correct orientation when replacing / assembling components.
- 2 Ensure that the stub axle is free from dirt and the nut and outer bearing can easily slide on it.
- 3 Tighten the crown nut with a hand spanner (a torque wrench is not required) while turning the hub clockwise until the bearing drags slightly (you feel the hub turning heavily). Some resistance will be due to friction from the seal.
- 4 Turn back the crown nut to the next locking position. Even if the tightening of the nut has reached an exact fixing position, turn it back.
- 5 Insert the retaining pin.
- 6 Try to shake/rock the outer edge of the hub/spindle: play of 0.1 / 0.2mm will not reduce the bearings' life and, in addition, prevents overheating. If the adjustment is correct the hub should turn freely with the only friction being from the seal.



Fig. 5.01: Checking Disc Bearing Adjustment

### 5.3.2 Bearing Seals

It is important when replacing the labyrinth type bearing seals in disc hubs that the seal is fitted the right way round. The chamfered lip side should be at the outside of the bearing housing, nearest the disc arm (see Fig. 5.02). This chamfered lip prevents dirt ingress into the housing and also allows grease to be flushed through when greasing.

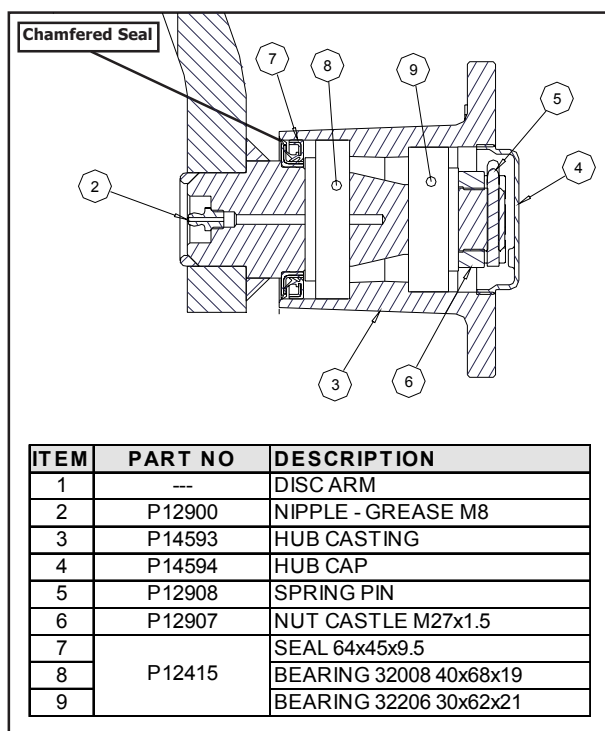

Fig. 5.02: Correct Seal Orientation

### 5.4 Terra-Grip Tine Points



Tine maintenance should be performed with the machine fully raised and with all taps closed.



When working under the machine ensure that the tractor handbrake is on.



When changing points on Terra-Grip tines extreme care should be taken. Wear goggles at all times when changing tine points.

### 5.5 Double Disc Axles

The axles on this roller are tensioned by the main axle through the centre of the rings and bearings.

Specialist equipment is required for the disassembly of Double Disc axles. Please consult your dealer under any circumstances that require disassembly of these axles.

Maintenance of these rollers is limited to daily greasing of the bearings to flush out dirt, and regular inspection to ensure the assemblies are tight, and scrapers are correctly set. The axles can be tightened provided the bearing pillar 'U' bolts are loosened to avoid preloading the bearings as they move sideways to each other. Ensure the bearing pillars are re-tightened to the mainframe after this.

### 5.6 Wing Pitch

On SL700 Models, the pitch of the wings can be altered by using the threaded ends of the wing cylinders. Tightening the will raise the outer tips of the wings and loosening will lower the outer tips.

### 5.7 Brakes & Wheel Hubs

The brakes should be tested before using for the first time and after the first laden journey.



Check that the road and parking brakes operate and release correctly before using the machine.



Check for hydraulic fluid and air leaks.



Brake and wheel hub maintenance and servicing should be carried out by an authorised Simba dealer.

## 5.8 Hydraulics



A low oil flow should be used, i.e., tractor tickover or low flow selected during use.



The wing circuit is controlled by an overcentre valve contained within the manifold block which positively locks oil flow until pressurised by the tractor. System pressure can be retained in the circuit **even after depressurisation** of the tractor quick release couplings.



Exercise extreme care when checking the valve or circuits, and *under no circumstances* attempt to adjust or loosen fittings without prior reference to your authorised Simba dealer, and detailed maintenance instructions.

## 5.9 Preparation for Storage

If you need to store the machine for a longer period, observe the following points:

- Park the machine undercover if possible.
- Protect the roll / discs against rust. If you need to spray the implements with oil, use light biologically degradable oils, e.g. rape oil.



Cover any rubber sections before using oil sprays. These sections must not be oiled.

Remove any traces of oil with a suitable cleaning agent.

## 5.10 Operator Support

If you have a problem, please contact your dealer. They will endeavour to solve any problems which may occur and provide you with support at all times.

In order to enable your dealer to deal with problems as quickly as possible, it helps if you can provide them with the following data. Always state the:

- Customer Number
- Name and Address
- Machine Model
- Serial Number of Machine
- Date of Purchase and Operating Hours
- Type of Problem

## 5.11 Maintenance Intervals

Apart from daily maintenance, the maintenance intervals are based on the number of operating hours and time data.

Keep a record of your operating hours to ensure that the specified maintenance intervals are adhered to as closely as possible.

Never use a machine that is due for maintenance. Ensure that all deficiencies found during regular checks are remedied immediately.



Avoid sharp-edged and pointed parts (disc blades, etc.) when working on the machine.



Place the machine on suitable supports when working underneath! Do not work under a machine which is not supported!

On a new machine tighten all nuts and bolts after 5 hours work and again after 15 hours. This also applies to parts that have been moved or replaced. After the initial 15 hours of work a once a week check should be sufficient depending on daily work rates.

## 5.12 Maintenance Overview

Maintenance Overview			
	Instructions	Interval	Note
<b>After first operation</b>			
Check all screw, bolt and plug connections	Check they are firmly seated. Tighten / Secure if necessary	---	---
Check wheel studs for tightness	Check on delivery and before transporting the machine	---	---
Lubricate machine	See overview of lubricating points	---	Page 34
Brakes	Check function	---	Page 29
<b>During operation</b>			
Lubricate machine	See overview of lubricating points	---	Page 34
Wheel studs	Check tightness before transporting the machine	daily	---
Disc Angle Adjustment, Disc Pitch, Working Depth	Check setting and ensure they are firmly secured	daily	Page 22
Hydraulic system and components	Check seals, signs of crushing/wear, function and condition	daily	Page 31
Disc Hub Units	Check condition, mountings and smooth operation	daily	Pages 22, 28
Roll Axle bearings	Check condition, mountings and smooth operation	daily	Pages 23, 29
Double Disc roller ring segments	Check condition and ensure they are firmly secured	daily	Pages 23, 29
Safety devices (Transport Lock, Brakes)	Check condition and function	daily	Pages 16, 29
<b>After season</b>			
Lubricate machine	See overview of lubricating points	---	Page 34
Lubricate Transport Wheel Bearings	Disassemble hub and lubricate bearings before reassembling	---	Page 34
Bolts / Lock Bolts	Grease any exposed threads	---	---
Entire machine	Carry out cleaning and maintenance	---	---
Spray Double Disc roll with oil	Use biological oil if possible - cover rubber elements	---	---
Brakes & Wheel Hubs	Service	600 hours	Page 29
<b>After 4 years</b>			
Hydraulic pipes	Replace	MRL Anh I	EN 1533

Transport Wheel Nut Torques & Tyre Pressures						
Hub	Spanner (mm)	Stud	Torque (Nm)	Tyres	Ply	Max Tyre Pressure
6 Stud	20	M18x1.5	270	500/50-17	14	50psi / 3.5 bar
10 Stud	30	M22x1.5	510	700/50-22.5	12	35psi / 2.4 bar

### 5.13 Overview of Lubricating Points

SL700 Lubrication Points	Interval	Diag. No.
DD Roll Bearings	10 Hours	5.03
Disc Hub Bearings	200 Hours *	5.04
Drawbar Pivot	100 Hours	5.05
Tine Frame Pivots	100 Hours	5.06
Transport Axle Pivot	100 Hours	5.07
Wing Pivots	100 Hours	5.08
Roll Carriage Pivot	100 Hours	-
Wing Pivots	100 Hours	-
Depth Wheel Bearings	100 Hours	-

\* See page 35, section 5.16 for details

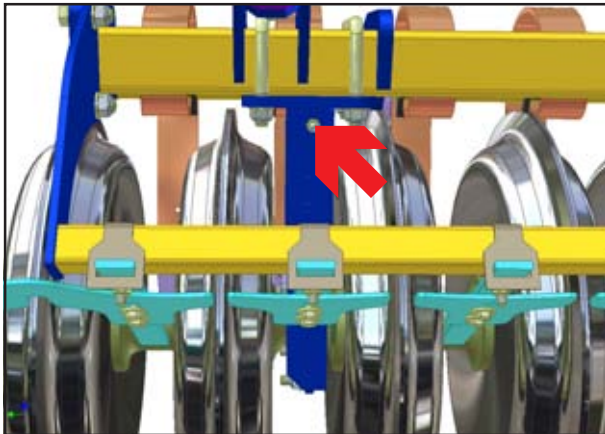

Fig. 5.03: DD Roll Grease Points

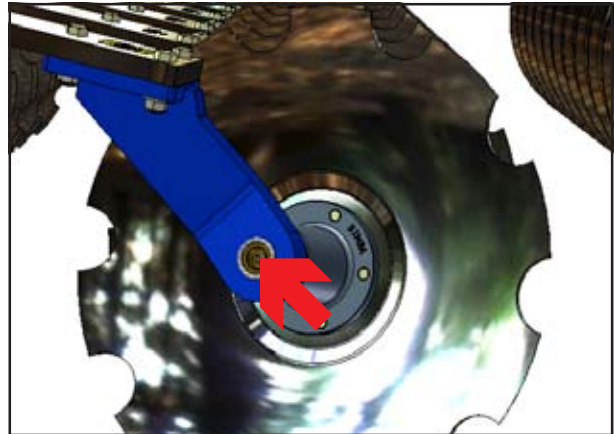

Fig. 5.04: Disc Hub Grease Points

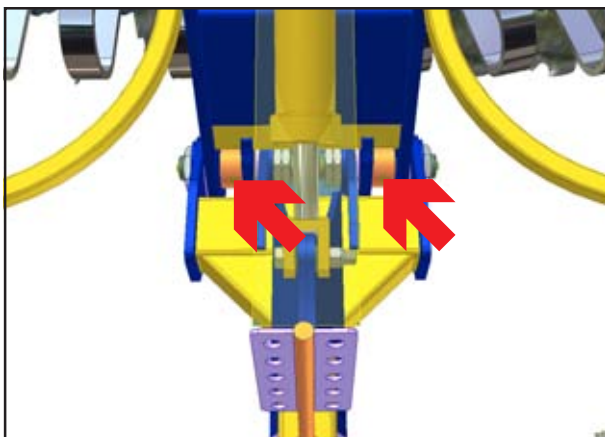

Fig. 5.05: Drawbar Pivot Grease Points



Fig. 5.06: Tine Frame Pivot Grease Points

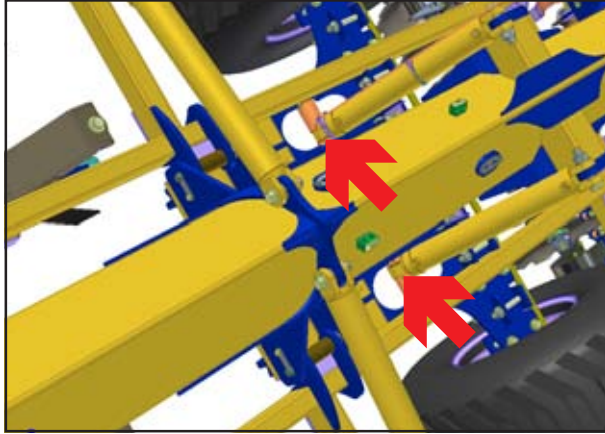

Fig. 5.07: Transport Axle Grease Points

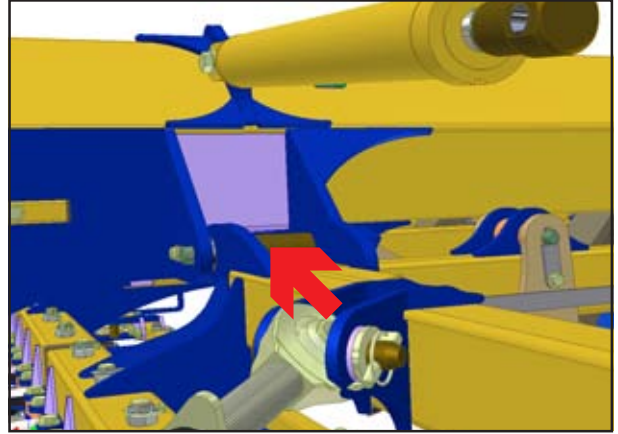

Fig. 5.08: Wing Pivot Grease Points

## 5.14 Lubricating the Machine

Please read the section entitled "Using Lubricants" carefully before lubricating the machine.

The machine must be lubricated regularly in order for it to remain serviceable. Regular lubrication also contributes towards extending the service life of your machine.

The recommended lubricating intervals are specified in "Inspection" and "Maintenance Intervals".

After it has been washed using a high-pressure hose or steam cleaned, the machine should always be lubricated using a grease gun. Ensure that the universal joints and splined shafts are lubricated regularly.

## 5.15 Handling of Lubricants

Please ensure that you read the following instructions as well as the relevant information. This also applies to any of your employees who handle lubricants.

### Hygiene

Lubricants do not present a health hazard provided they are used for their specified purpose.

In the case of prolonged skin contact, lubricants - especially low-viscosity oils - may remove the natural layer of fat contained in the skin, resulting in dryness and possible irritation.

It is important to take extreme care when handling waste oil as it may contain other irritants.

Vapours given off by cleaning agents and oils are also a potential health hazard.

You should therefore not carry any oily cloths around. Change soiled work clothing as soon as possible.

Always exercise extreme care and observe the recommended hygiene rules when handling mineral oil products. Details of these handling regulations can be found in information provided by the health authorities.

### Storage and Handling

- Always store lubricants where they cannot be accessed by children.
- Never store lubricants in open or unlabelled containers.

### Fresh Oil

- Apart from taking the usual care and observing hygiene rules, there is no need to take any special precautions when handling fresh oil.

### Waste Oil

- Waste oil can contain harmful contaminants which may cause skin cancer, allergies and other illnesses.

### Attention!

Oil is a toxic substance. Should you swallow any oil, do not try to vomit. Contact a doctor immediately.

Protect your hands with barrier cream or wear gloves to avoid contact with the skin. Wash off any traces of oil thoroughly with soap and hot water.

- Wash your skin thoroughly with soap and water.
- Use special cleaning agents to clean any dirt off your hands.
- Never wash oil residue from your skin with petrol, diesel fuel or paraffin.
- Avoid skin contact with any oily clothing.
- Do not keep any oily rags in your pockets.
- Wash soiled clothing before wearing it again.
- Ensure that any oily footwear is disposed of in the proper manner.

## Measures in case of injury through oil

### Eyes:

Should any oil be splashed into your eyes, rinse with water for 15 minutes. If the eye is still irritated, contact a doctor immediately

### If oil is swallowed

If oil is swallowed, it is important not to induce vomiting. Contact a doctor immediately.

### Skin irritation caused by oil

In case of prolonged skin contact, wash off the oil with soap and water.

### Oil Spills

Use either sand or a suitable granular absorbent to soak up any spilt oil. Dispose of the oil-contaminated absorbent in the proper manner.

### Oil Fires

Never use water to extinguish an oil fire. The oil will float on the water causing the fire to spread.

Burning oil/lubricant must be extinguished using a carbon dioxide powder or foam extinguisher. Always wear respiratory equipment when dealing with fires of this type.

### Waste Oil Disposal

Oil-contaminated waste and used oil must be disposed of in accordance with current legislation.

Waste oil must be collected and disposed of in accordance with local regulations. Never pour used oil into unsealed sewage systems or drains or onto the ground.

## 5.16 Lubricants & Hydraulic Oil

### Hydraulic System

The hydraulic fluid from the tractor is mixed with the hydraulic fluid from the machine.

The supplied machine hydraulic system contains Total AZOLLA ZS 32 oil.

### Lubricants

Simba strongly recommend the use of **Lithium Complex EP2 Grease** in the disc and wheel hubs of your SL700. This grease is a Lithium Complex soap dispersed in a mineral oil and is interpreted by IARC as being non-carcinogenic. Grease cartridges are available from Simba (P12710). Using this grease in combination with the labyrinth type seal it is permissible to lengthen the greasing interval on the disc hubs to 200 hours. If using a standard agricultural grease the disc hubs should be lubricated every 50 hours.

#### Advantages of Lithium Complex EP2 Grease

- Excellent mechanical stability.
- Excellent load carrying properties.
- Wide temperature range.
- Excellent oxidation stability.
- Excellent water resistance.
- Compatability with other greases.

All other lubricating points on the machine can be lubricated with multigrade lubricating grease as specified in DIN 51825 KP/2K - 40.

## 6. Faults and Remedies

SL700 Troubleshooting		
Fault	Possible cause	Remedy
Machine pulls to one side	Discs set unevenly	Adjust each pair of disc gangs
	Tines set unevenly	Adjust tine depth
	Roll blocked	Unblock roll
Machine not running level front to rear (if not deliberate)	Machine set incorrectly	Adjust drawbar shims to compensate or if nose diving decrease rear roll pressure.
Transport wheels fail to lift machine	Tractor relief valve operating tractor hydraulics worn	Decrease flow rate
Discs fail to penetrate	More depth needed	Adjust depth control
	Gang angle too little	Check gang settings and increase gang angle if appropriate
	Blades worn	Replace blades
Machine pulling up clods	Chassis running nose down	Add shims to drawbar cylinder
Rear disc dragging up wet soil	Chassis running tail low	Remove shims from drawbar cylinder